

Product Specifications
and Technical Information

AndyLOOS
PLACED FOR YOUR CONVENIENCE

Alvac Vacuum System

Luxury individual modular units allowing multiple configurations.

Styles:	Original Black & White and Oak*		
Size: Urinals (3)	Depth: 1.7m	Width: 1.9m	Height: 2.2m
W/C	Depth: 1.9m	Width: 1.08m	Height: 2.2m
Vanity (2)	Depth: 1m	Width: 1.9m	Height: 2.1m
Disabled	Depth: 1.85m	Width: 1.85m	Height: 2.2m

Power required: 3 phase/32 Amp with additional single phase supply 16 Amp 3.5kVa.

Weight: Urinal & WC 300kgs.
Vanity 280kgs Disabled 400kgs.

Water/Waste: Water – needs mains supply.
Waste – expels to main sewer or into storage tanks.

Position: Needs to be in weatherproof structure.

Disabled Access: A disabled access unit with ramp and handrail can be incorporated into any installation.

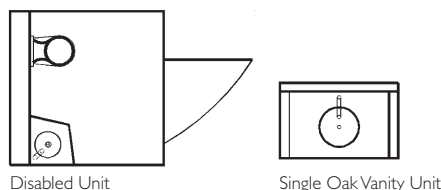
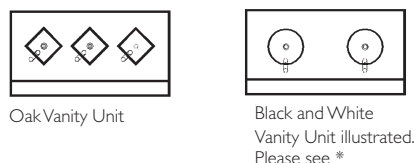
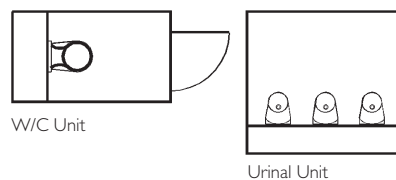

* Black and white vanity has 2 raised porcelain hand wash bowls. Oak vanity has 3 raised glass hand wash bowls.

Alvac Event

Luxury two vacuum toilet cubicles in one waterproof pod.

Size: Cabin Depth: 1260mm Width: 2350mm Height: 2240mm

Cubical Interior Depth: 1190mm Width: 1140mm Height: 2100mm

Power required: Single phase 16 Amp/3.5kVa.

Weight: 696kg.

Water/Waste: Water – needs mains supply.
Waste – expels to main sewer or into storage tanks.

Capacity: Up to 100 people per day. Position: Needs firm and level ground with good access.

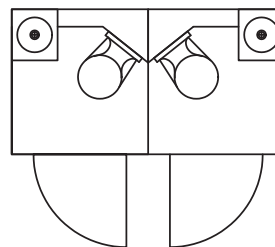

Millennium

Luxury trailer with access steps and hand rails.

Size: Cabin Length: 5.6m Width: 2.3m Height: 3.2m

A Frame Length: 1.2m

Power required: Single phase 16amp/3.5kVa.

Weight: 2800kg.

Water/Waste: Self-contained.
Optional mains water and drainage connection.

Capacity: Up to 300 people per day.

Position: Firm level ground with good access.

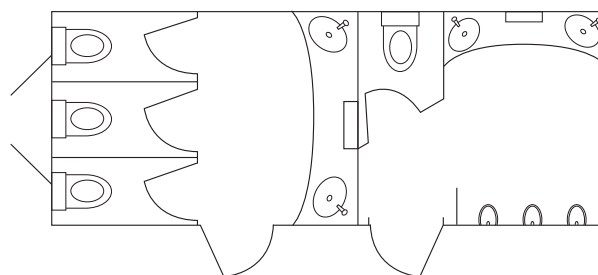

TRIO

Luxury trailer with access steps and hand rails.

Size: Cubicle Depth: 2.26m Width: 1.3m Height: 2.1m

Trailer Length: 4.0m Width: 2.3m Height: 3.2m

A Frame Length: 1.2m

Power required: Single phase 16amp/3.5kVa.

Weight: 2300kg.

Water/Waste: Self-contained.
Optional mains water and drainage connection.

Capacity: Up to 150 people per day.

Position: Firm level ground with good access.

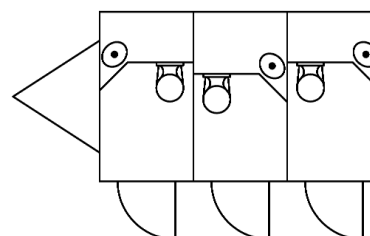

PLEASE NOTE THAT WE DO NOT SUPPLY GENERATORS.

Abberley

4+2 and 4+4 Trailers with access steps and hand rails.

Size: Cabin	Length: 6.38m	Width: 2.5m	Height: 3.0m
A Frame	Length: 1.2m		
Power required:	Single phase 16amp/3.5kVa.		
Weight:	2800kg.		
Water/Waste:	Self-contained. Optional mains water and drainage connection.		
Capacity:	4+2 trailer and 4+4 trailer – Both up to 600 people per day.		
Position:	Firm level ground with good access. 4+2 contains baby change facility. It can also be converted to all male or all female.		

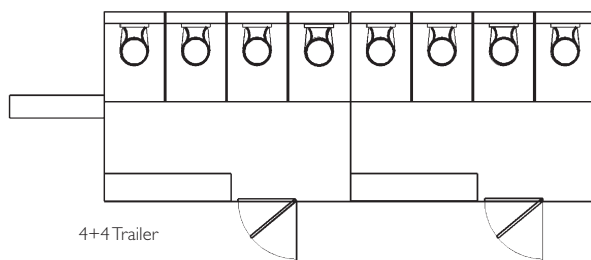

4+4 Trailer

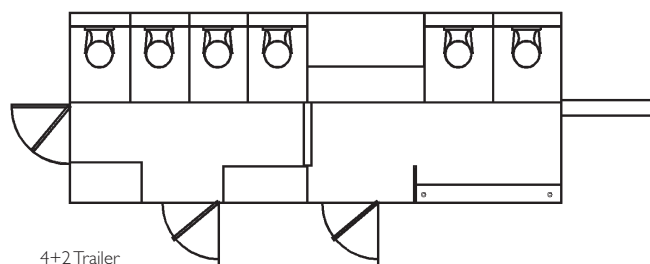

4+2 Trailer

Duo

Trailer with access steps and hand rails.

Size: Cabin	Length: 3.1m	Width: 2.1m	Height: 3.2m
A Frame	1.3m		
Power required:	Single phase 16 Amp/3.5kVa.		
Weight:	1800kg.		
Water/Waste:	Self-contained. Optional mains water and drainage connection.		
Capacity:	Up to 100 people per day.		
Position:	Firm level ground with good access.		

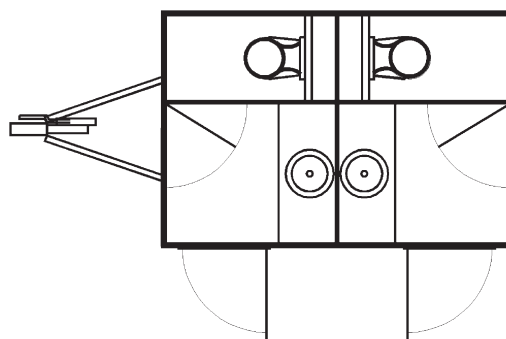

Elmley

Trailer with access steps and hand rails.

Size: Cabin	Length: 4.0m	Width: 2.3m	Height: 3.2m
A Frame	1.2m		
Power required:	Single phase 16 Amp/3.5kVa.		
Weight:	2300kg.		
Water/Waste:	Self-contained. Optional mains water and drainage connection.		
Capacity:	Up to 200 people per day.		
Position:	Firm level ground with good access.		

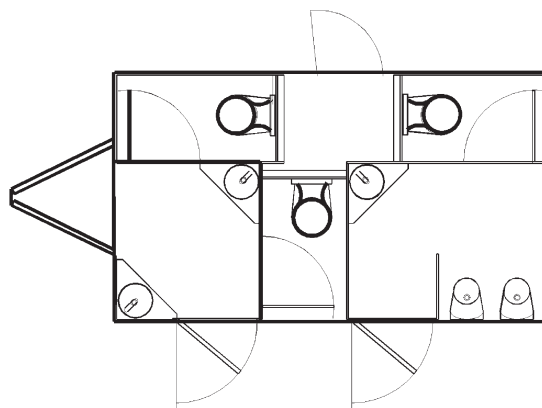

Duchess

Trailer with access steps and hand rails.

Size: Cabin Length: 6.3m Width: 2.45m Height: 3.0m
 A Frame: Length: 1.35m
 Power required: Single phase 16amp/3.5kVa.
 Weight: 2800kg.
 Water/Waste: Self-contained.
 Optional mains water and drainage connection.
 Capacity: Up to 600 people per day for 6+2.
 Up to 500 people per day with 3+2
 Position: Firm level ground with good access.
 Both sizes of these trailers can be converted to all male or all female.

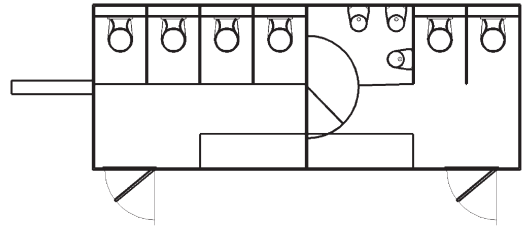

4+2 illustrated; also available as 3+2.

Six-Vac*

Fully portable vacuum toilet block with baby change included and access steps.

Size: Length: 2.94m Width: 2.41m Height: 2.6m
 Power required: Variable, according to quantity of units required - we will advise.
 Weight: 1600kg.
 Water/Waste: Water supply required.
 Waste extraction is by vacuum to external tank - no chemicals used.
 Waste can be discharged to mains if available on site.
 Capacity: Up to 600 people per day.
 Position: Firm level ground with good access.
 *We have Re-circulation/Mains versions of this unit also available.

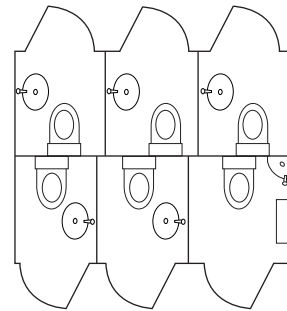

Individual Units

Description	Depth	Width	Height	Weight	Power Required	Water/Waste	Position
Single WC	1.2m	1.2m	2.4m	80kg	Not required	Self-contained	Flat level ground with good access
Ease of Access	1.55m	1.55m	2.4m	127kg	Not required	Self-contained	Flat level ground with good access
Standard Urinal	1.55m	1.55m	2.4m	132kg	Not required	Self-contained	Flat level ground with good access
Single Shower Gas	1.2m	1.2m	2.4m	100kg	LPG propane	Requires water supply	Flat level ground with good access
Single Shower EAU Gas	1.55m	1.55m	2.4m	127kg	LPG propane	Requires water supply	Flat level ground with good access

Poly-Vac

Our non-chemical Poly-Vac WCs and Ease of Access WC have the same dimensions and weight as the WCs above but do require a power and water supply. Please contact us for more information.

Moovaloo

Two self-contained toilets or self-contained gas-powered showers.

Central cold water tank for handwashing.

Size: Length: 4040mm Width: 3180mm Height: 2680mm
 (including A Frame) (including wheels)
 Weight: 450kg.
 Water-Tank: Width: 450mm Depth: 1100mm Height: 650mm

Uro Cabins

Trailer with fitted hand sanitisers, access steps and hand rails.

Size: Cabin	Various lengths from 4 to 6 metres.
A Frame	Length: 1.2m
Power required:	Single phase 16amp/3.5kVa.
Weight :	2000kg.
Water/Waste:	Self-contained. Optional drainage connection.
Capacity:	1000 people per hour.
Position:	Firm level ground with good access.

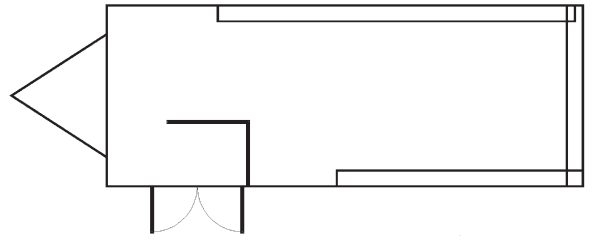

Transshowers

Luxury Shower Trailer with access steps and hand rails.

Size: Cabin	Length: 5.0m	Width: 2.3m	Height: 3.2m
A Frame	Length: 1.2m		
Required:	Single phase 16amp/3.5kVa and LPG propane gas supply.		
Weight:	2000kg.		
Water/Waste:	Mains water pressure and drainage connection required. Optional reservoir and pump available.		
Position:	Firm level ground with good access.		

* 4 bay jack leg standard shower units also available.

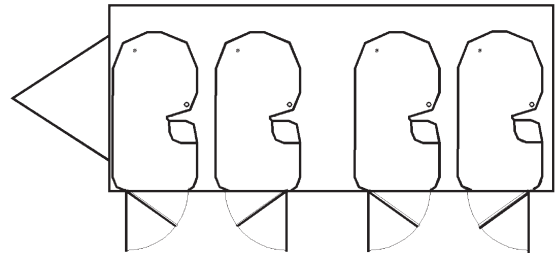

SPECIAL NEEDS

Luxury Toilet with Disabled Access

Size:	Length: 2.4m	Width: 1.9m	Height: 2.3m
Threshold:	Height 19cm	Ramp Length 1m	
Power required:	Single phase 16amp/3.5kVa.		
Weight:	1000kg.		
Water/Waste:	Self-contained, optional mains water drainage connection.		
Capacity:	Up to 100 people per day.		
Position:	Firm level ground with good access		

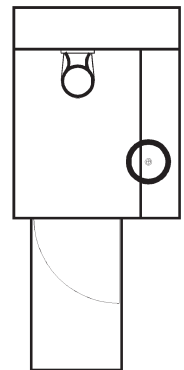

High Dependency Mobile Unit

Size:	Length 5.1m (+1.7m draw bar)	Width: 2.5m	Height: 2.85m
Threshold:	Height 34cm	Ramp Length: 2.6m	
Power required:	Single phase 16amp/3.5kVa.		
Weight:	2300kg.		
Water/Waste:	Self-contained, optional mains water drainage connection.		
Capacity:	Up to 30 people per day.		
Position:	Firm level ground required. Access ramp fitted.		
Hoist:	Fully automatic tracking with 160kgs SWL with both hoop and clip lifting frames available.		
Changing couch:	Fully height adjustable on large wheels for ease of movement.		
Security:	Provided with a radar lock and additional lock for overnight security.		
Heating:	Internal heater fitted.		

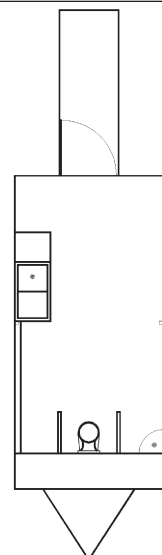

PLEASE NOTE THAT WE DO NOT SUPPLY GENERATORS.

For further technical and product information, please contact us using the telephone number or address given here,, or via our website.

Our company policy is one of continuous development and improvement. We therefore reserve the right to alter the design and construction of any of our units without notice.

Email: info@andyloos.co.uk

www.andyloos.co.uk

AndyLOOS
PLACED FOR YOUR CONVENIENCE

AndyLoos Limited

Unit 22, Hartlebury Trading Estate
Hartlebury
Worcestershire DY10 4JB

T: +44 (0) 1299 254420

F: +44 (0) 1299 251947